

SANYO

No.4424

LA6512,6513**High-Voltage
Dual Power Operational Amplifiers****Overview**

LA6512 (SIP10F) and LA6513 (SIP10) are power operational amplifier ICs capable of withstanding high voltages of ± 30 V/1 A and are best suited for such voltage division devices as LCD drivers and general-purpose power operational amplifiers.

Features

- High output current (I_O max = 1.0A)
- High gain
- Equipped with current limiter pin (Adjustable by external settings)
- Supports single power source operation
- Withstands high voltages (± 30 V)

Package Dimensions

unit : mm

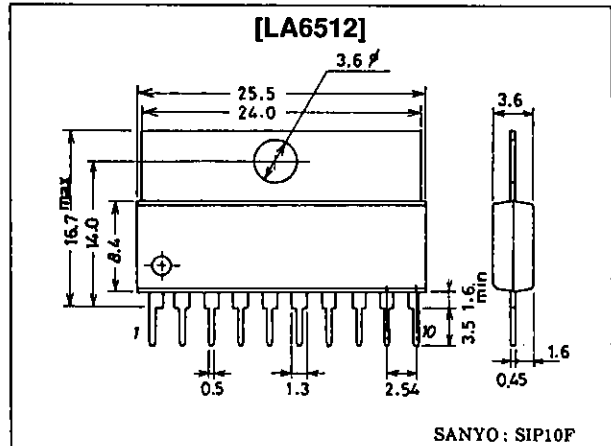
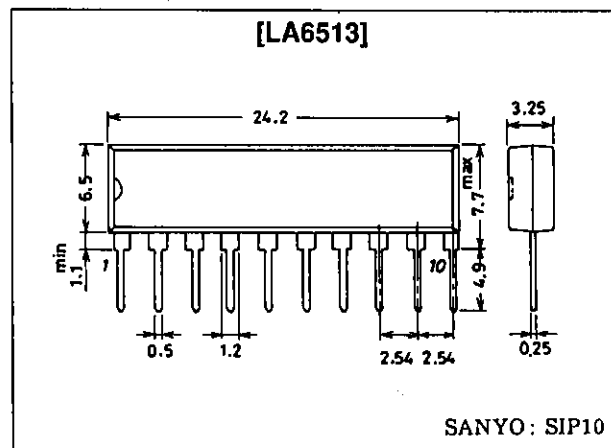
3046B-SIP10F**3043A-SIP10****Specifications****Maximum Ratings at $T_a = 25^\circ\text{C}$**

			unit	
Maximum supply voltage	V_{CC}/V_{EE} max	± 30	V	
Differential input voltage	V_{IDIF}	56	V	
Common mode input voltage	V_{ICOM}	± 28	V	
Maximum output current	I_O max	1.0	A	
Allowable power dissipation	P_d max	LA6512	2.5	W
		LA6513	1.3	W
Operating temperature	T_{opr}	-20 to +75	$^\circ\text{C}$	
Storage temperature	T_{stg}	-55 to +150	$^\circ\text{C}$	

SANYO Electric Co., Ltd. Semiconductor Business Headquarters
TOKYO OFFICE Tokyo Bldg., 1-10, 1 Chome, Ueno, Taito-ku, TOKYO, 110 JAPAN

41893TS A8-9798.9799 No.4424-1/4

Operating Characteristics at Ta = 25°C, V_{CC}/V_{EE} = ±15

			min	typ	max	unit
No-load dissipation current	I _{CCO}		6	12	20	mA
Input offset voltage	V _{IO}	R _s ≤ 10kΩ		2	6	mV
Input offset current	I _{IO}			10	200	nA
Input bias current	I _B			100	700	nA
Common mode input voltage range	V _{ICM}		-14		13	V
Common mode signal rejection ratio	C _{RM}		70	80		dB
Maximum output voltage	V _O max		±12	±13		V
Voltage gain	V _G O			100		dB
Slew rate	SR	G _V = 0, R _L = 33Ω, R = 2.2Ω, C = 0.1μF		0.15		V/μs
Supply voltage rejection ratio	SVRR			30	150	μV/V
Limiting current	I _{SC}	R _{SC} = 2.2Ω		0.35		A

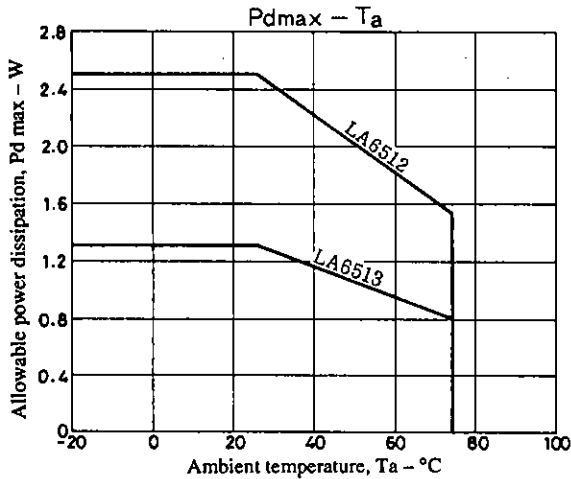

Information (including circuit diagrams and circuit parameters) herein is for example only ; it is not guaranteed for volume production.

SANYO believes information herein is accurate and reliable, but no guarantees are made or implied regarding its use or any infringements of intellectual property rights or other rights of third parties.

Pin Assignment

(LA6512, 6513 common)

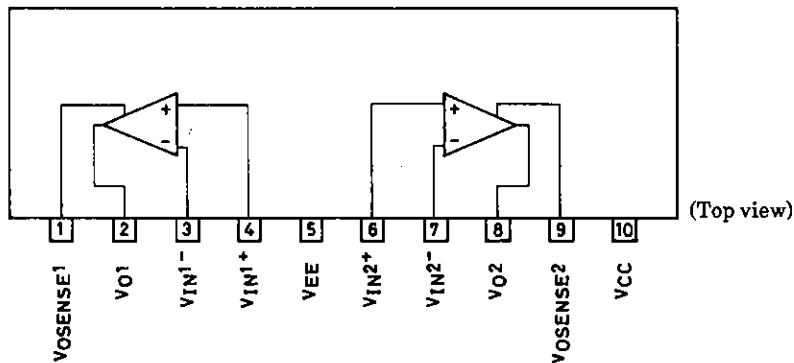

Test Circuit

I_{CC}

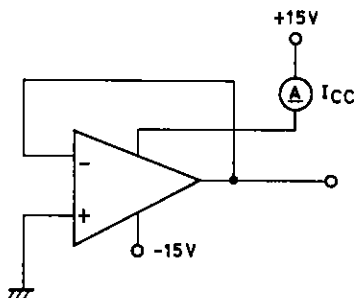

V_{IO}, SVRR

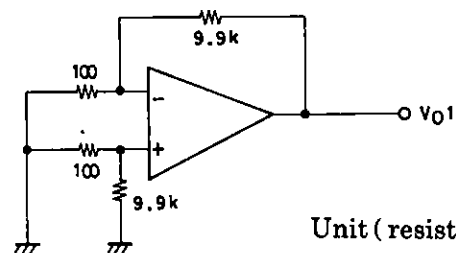

Unit (resistance:Ω)

- V_{IO} is with V_{CC}/V_{EE} = ±15 V
- V_{IO} = VO1/100
- SVRR is with [V_{CC} = 15,5V / V_{EE} = -5, -15V]
- SVR (+) = ΔV_{O1} / (100 x 10V)
- SVR (-) = ΔV_{O1} / (100 x 10V)

Continued on next page.

Continued from preceding page.

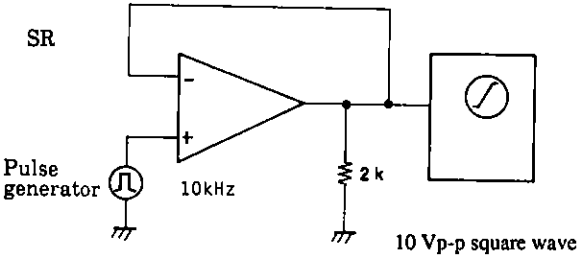
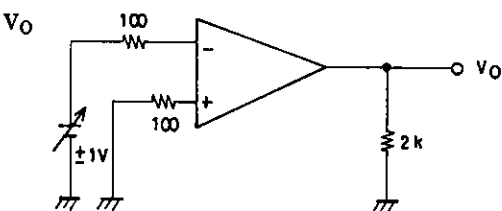
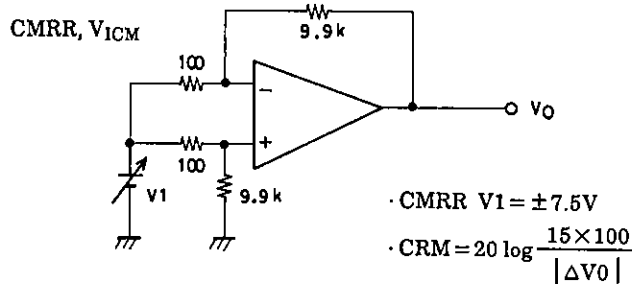
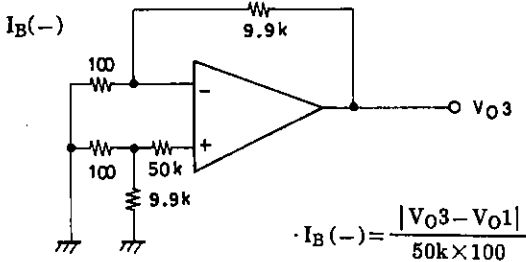
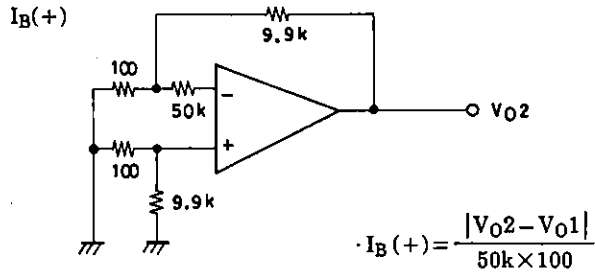
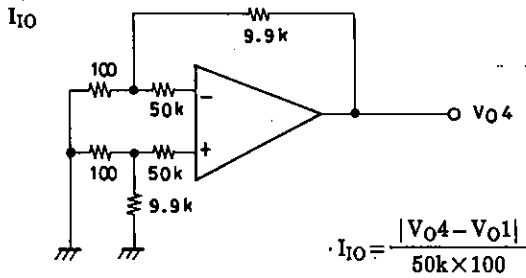

Application Circuit Example

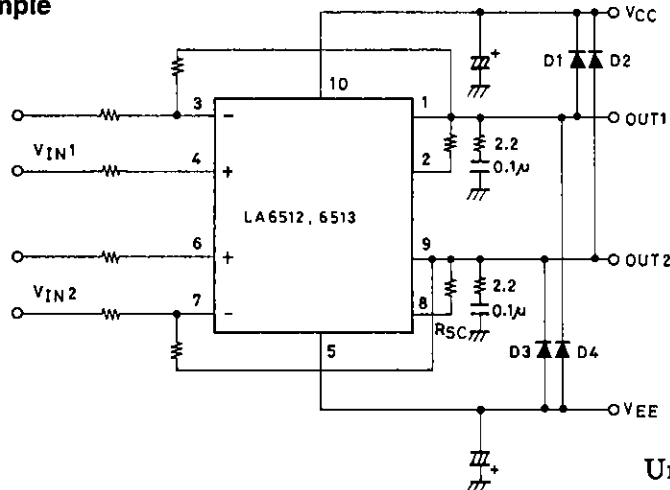

Unit (resistance:Ω capacitance:F)

Note: When driving an inductive load, a D1 to D4 protective diode should be installed.

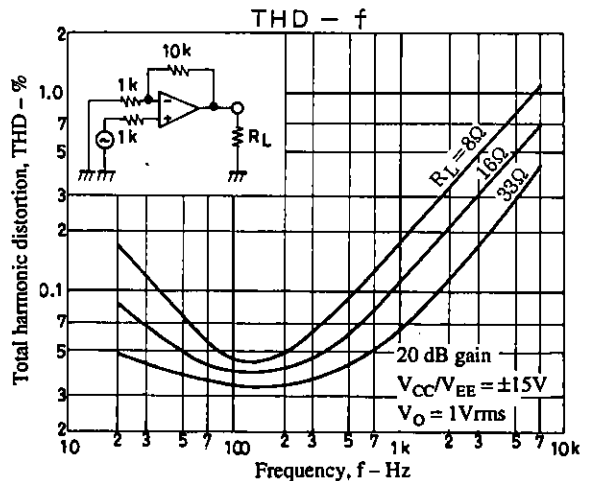
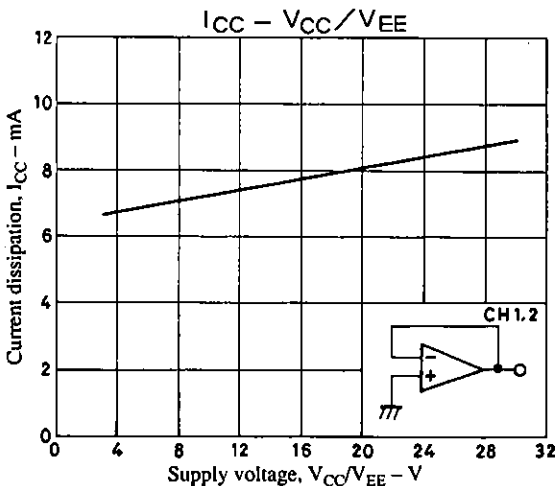

- No products described or contained herein are intended for use in surgical implants, life-support systems, aerospace equipment, nuclear power control systems, vehicles, disaster/crime-prevention equipment and the like, the failure of which may directly or indirectly cause injury, death or property loss.
- Anyone purchasing any products described or contained herein for an above-mentioned use shall:
 - ① Accept full responsibility and indemnify and defend SANYO ELECTRIC CO., LTD., its affiliates, subsidiaries and distributors and all their officers and employees, jointly and severally, against any and all claims and litigation and all damages, cost and expenses associated with such use:
 - ② Not impose any responsibility for any fault or negligence which may be cited in any such claim or litigation on SANYO ELECTRIC CO., LTD., its affiliates, subsidiaries and distributors or any of their officers and employees jointly or severally.
- Information (including circuit diagrams and circuit parameters) herein is for example only; it is not guaranteed for volume production. SANYO believes information herein is accurate and reliable, but no guarantees are made or implied regarding its use or any infringements of intellectual property rights or other rights of third parties.